



 **bioentry** **Plus**

IP based Fingerprint Access Control

Installation Guide

(ver 1.2)

www.supremainc.com

Contents

Safety precautions	3
Basics of fingerprint recognition	5
How to place a finger	6
Product Contents	8
Front Side	10
Bottom and Back Side	11
Product Dimension	12
Cables and Connectors	13
Installation of Wall-mount Bracket	14
Power Connection	15
Ethernet Connection	16
RS485 Connection	18
Relay Connection	20
Digital Input Connection	23
Wiegand Output	25
Network Default Setting	26
Installation Reference	27
Electrical Specification	30
Troubleshooting	31
Device cleaning	32
FCC Rules	33
Specifications	34

Safety precautions

- The list below is to keep user's safety and prevent any loss. Please read carefully before use.

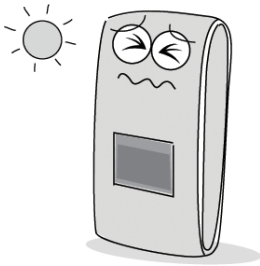

Do not install the device in a place subject to direct sun light, humidity, dust or soot.

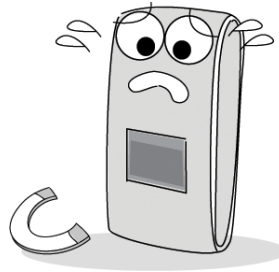

Do not place a magnet near the product. Magnetic objects such as magnet, CRT, TV, monitor or speaker may damage the device.

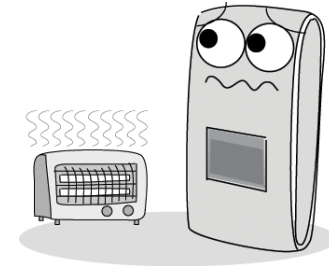

Do not place the device next to heating equipments.

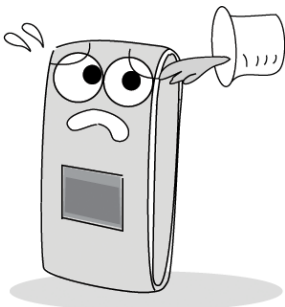

Be careful not to let liquid like water, drinks or chemicals leak inside the device.



Clean the device often to remove dust on it.



In cleaning, do not splash water on the device but wipe it out with smooth cloth or towel.

Safety precautions

- The list below is to keep user's safety and prevent any loss. Please read carefully before use.

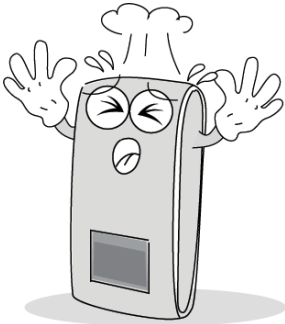

Do not drop the device.



Do not damage the device.



Do not disassemble, repair or alter the device.



Do not let children touch the device without supervision.

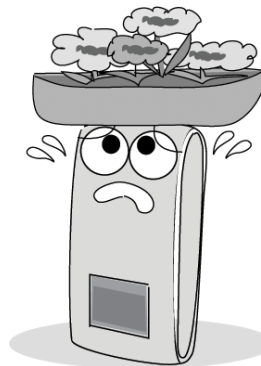

Do not use the device for any other purpose than specified.

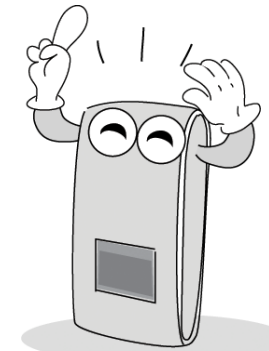

Contact your nearest dealer in case of a trouble or problem.

Basics of fingerprint recognition

■ What is fingerprint recognition?

- Fingerprint is an individual's own biometric information and does not change throughout his/her life. Fingerprint recognition is a technology that verifies or identifies an individual using such fingerprint information.
- Free from the risk of theft or loss, fingerprint recognition technology is being widely used in security systems replacing PIN or cards.

■ Process of fingerprint recognition

- Fingerprint consists of ridges and valleys. Ridge is a flow of protruding skin in a fingerprint while valley is a hollow between two ridges. Each individual has different pattern of ridges and valleys and finger recognition makes use of such originality and uniqueness of these patterns.
- Fingerprint sensor generates 2-dimensional fingerprint image using different technology. According to the sensing technology, fingerprint sensors are classified into optical, capacitive, or thermal.
- Fingerprint template is a collection of numeric data representing the features of a fingerprint. Fingerprint templates are saved inside the memory of BioStation and used for identification.

■ Secure way to protect personal information

- To avoid privacy concern, Suprema's fingerprint products do not save fingerprint images itself. It is impossible to reconstruct a fingerprint image from a fingerprint template which is just numeric data of the features of a fingerprint.

How to place a finger

Suprema's fingerprint products show an outstanding recognition performance regardless of the user's fingerprint skin condition or the way of fingerprint positioning. However, following tips are recommended to get more optimal fingerprint recognition performance.

■ Select a finger to enroll

- It is recommended to use an index finger or a middle finger.
- Thumb, ring or little finger is relatively more difficult to place in a correct position.

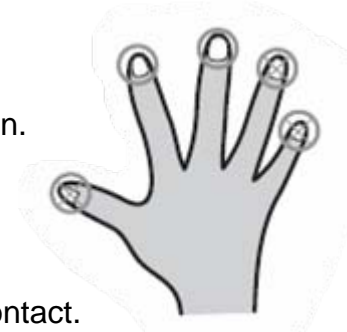

■ How to place a finger on a sensor

- Place a finger such that it completely covers the sensor area with maximum contact.
- Place core part of a fingerprint to the center of a sensor.
 - People tend to place upper part of a finger.
 - The core of a fingerprint is a center where the spiral of ridges is dense.
 - Usually core of fingerprint is the opposite side of the lower part of a nail.
 - Place a finger such that the bottom end of a nail is located at the center of a sensor.
- If a finger is placed as in the right picture, only a small area of a finger is captured. So it is recommended to place a finger as shown in the left picture.

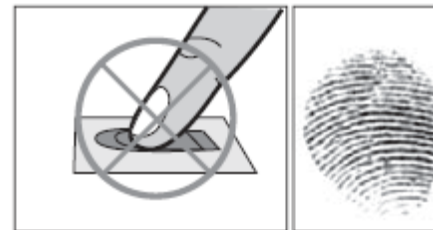
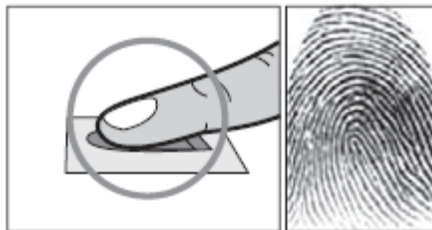

How to place a finger

■ **Tips for different fingerprint conditions**

- Suprema's fingerprint products are designed to scan fingerprint smoothly regardless of the conditions of a finger skin. However, in case a fingerprint is not read well on the sensor, please refer to the followings tips.
 - If a finger is stained with sweat or water, scan after wiping moisture off.
 - If a finger is covered with dust or impurities, scan after wiping them off.
 - If a finger is way too dry, place after blowing warm breath on the finger tip.

■ **Tips for fingerprint enrollment**

- In fingerprint recognition, enrollment process is very important. When enrolling a fingerprint, please try to place a finger correctly with care.
- In case of low acceptance ratio, the following actions are recommended.
 - Delete the enrolled fingerprint and re-enroll the finger.
 - Enroll the same fingerprint additionally.
 - Try another finger if a finger is not easy to enroll due to scar or worn-out.
- For the case when an enrolled fingerprint cannot be used due to injury or holding a baggage, it is recommended to enroll more than two fingers per user.

Product Contents

■ Basic Contents



BioEntry Plus



Wall-mounting metal bracket



Wall mounting screws – 2 ea



Star-shaped screws



Star-shaped small wrench

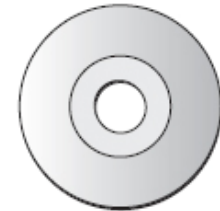

Software CD



3 pin, 4 pin, 5 pin, 7 pin cables – each 1 ea

Product Contents

- **Optional accessories**



Secure I/O

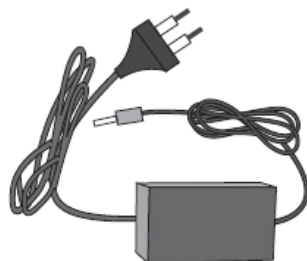

12V power adaptor



Plastic stand



USB fingerprint scanner
for enrollment on PC

Front Side

■ Front



← RF card reading part
Place an RF card over the picture

← LED
Display current status using seven different colors

← Fingerprint sensing part
Place a finger on a sensor surface

LED Status per Color

- Green : Authorization Success
- Red : Authorization Fail
- Pink : On Processing
- Flicker Blue/Sky-Blue Color per 2sec : Normal
- Flicker Red/Pink Color per 2sec : Locked
- Flicker Blue/Red Color per 2sec : Initialized Time due to the Internal Battery Discharge
- Flicker Blue/Yellow Color per 2sec : DHCP Fail
- Flicker Red Color per 2sec : Failed. Please contact to your distributor or Suprema
- Flicker Yellow Color per 2sec : Waiting Input
- Flicker Yellow Color per 1sec : Receiving IP Address from DHCP server

Bottom and Back Side

■ Bottom

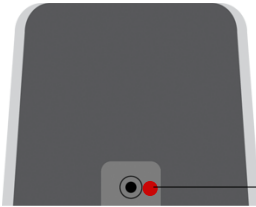

● Star-shaped screw hole for fixing a body to a metal bracket

■ Back

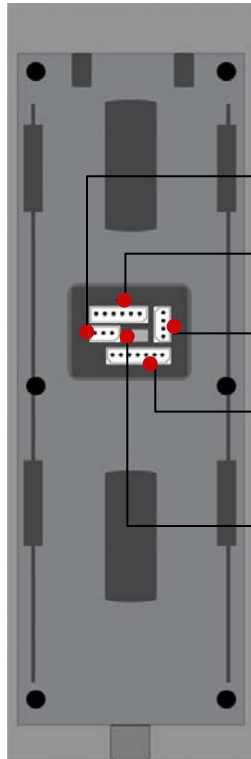

● 3 pin connector – wiegand input or wiegand output

● 5 pin connector – power and RS485

● 4 pin connector – ethernet (TCP/IP)

● 7 pin connector – digital input and relay output

● DIP switch : RS485 termination setting
 (Refer to “RS485 Connection” pages for details)
 Network default setting
 (Refer to “Network Default Setting” pages for details)

Product Dimension

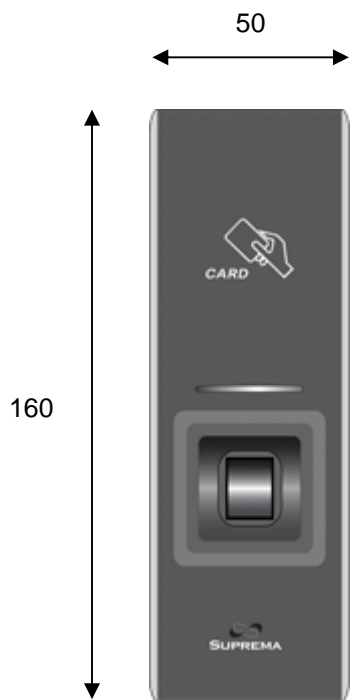

Front

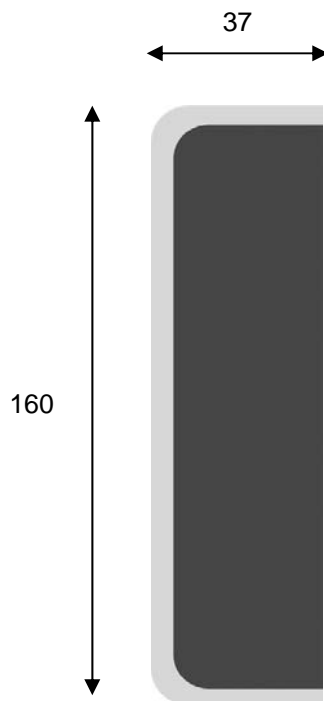

Side

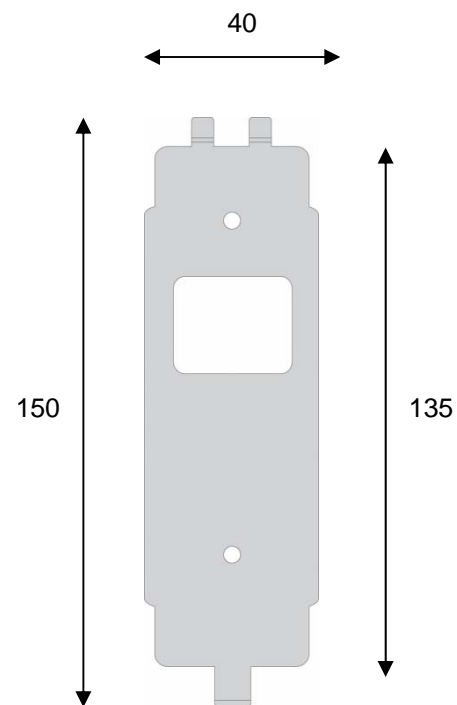

Metal Bracket

(unit : mm)

Cables and Connectors

Power and RS485



PIN	PIN DESCRIPTION	WIRE
1	POWER +12V	RED
2	POWER GND	BLACK
3	RS -485 GND	GRAY
4	RS -485 TRX+	BLUE
5	RS -485 TRX-	YELLOW

TCP/IP



PIN	PIN DESCRIPTION	WIRE	RJ45 PIN
1	TX +	YELLOW	6
2	TX -	GREEN	3
3	RX +	RED	2
4	RX -	BLACK	1

Wiegand In/output (Switchable)



PIN	PIN DESCRIPTION	WIRE
1	WIEGAND DATA0	GREEN
2	WIEGAND DATA1	WHITE
3	WIEGAND GND	BLACK

Digital Inputs and Relay output



PIN	PIN DESCRIPTION	WIRE
1	SW1 INPUT	YELLOW
2	SW1 GND	BLACK
3	SW2 INPUT	GREEN
4	SW2 GND	BLACK
5	RELAY NORMAL CLOSE	ORANGE
6	RELAY COMMON	BLUE
7	RELAY NORMAL OPEN	WHITE

Installation of Wall-mount Bracket

- Fix wall mount bracket on a wall using wall mounting screws

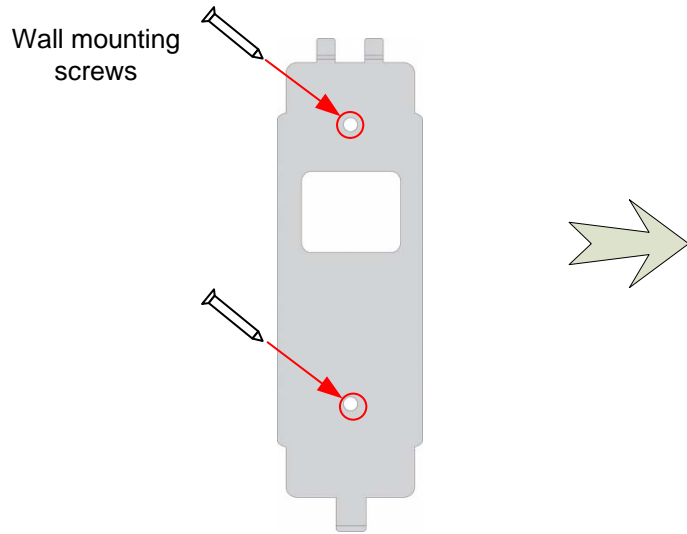

- Hook BioEntry Plus on the wall mount bracket

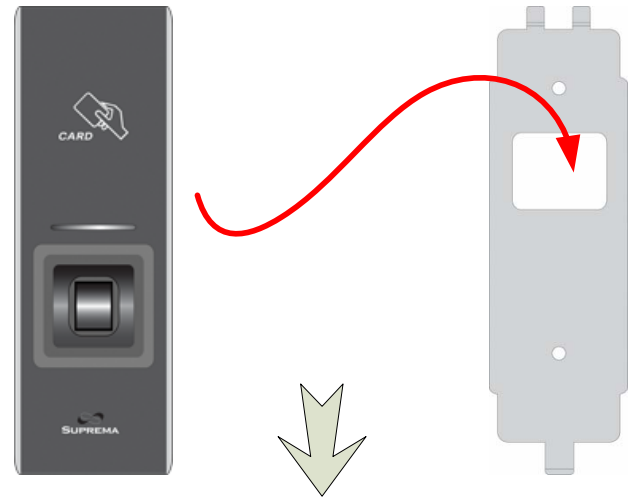

- Fix BioStation and wall mounting bracket using a star shape screw.

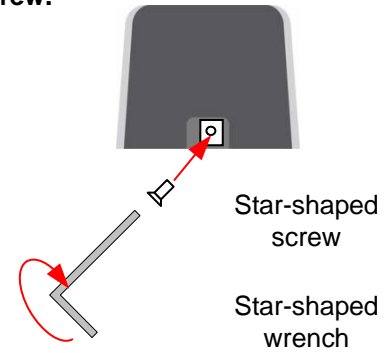

Power Connection

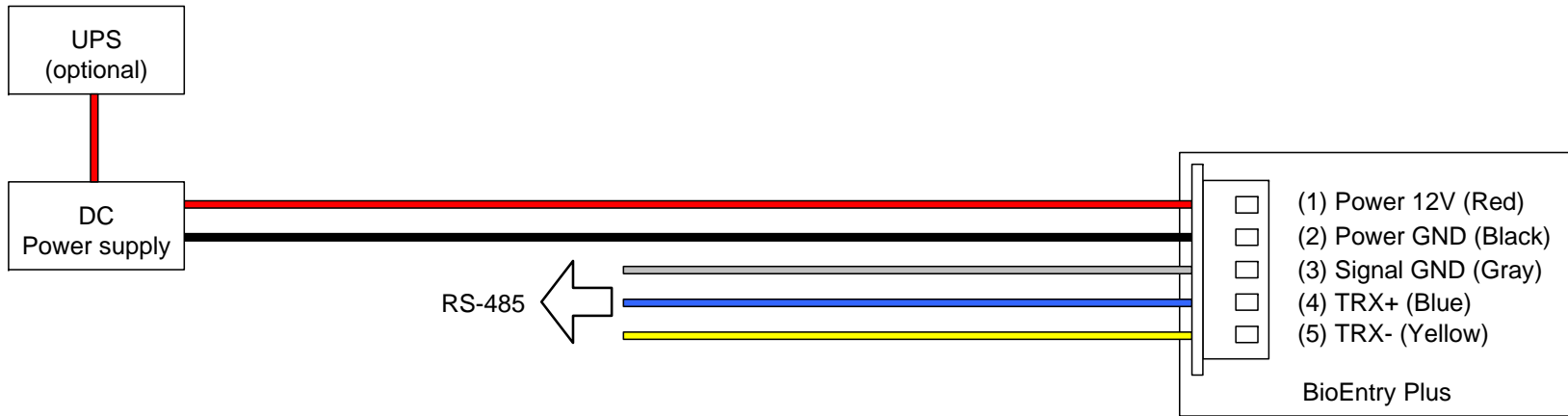

- **Recommended power supply**
 - 12V \pm 10%, at least 500mA.
 - Comply with standard IEC/EN 60950-1.
 - To share the power with other devices, use a power supply with higher current ratings.

Ethernet Connection

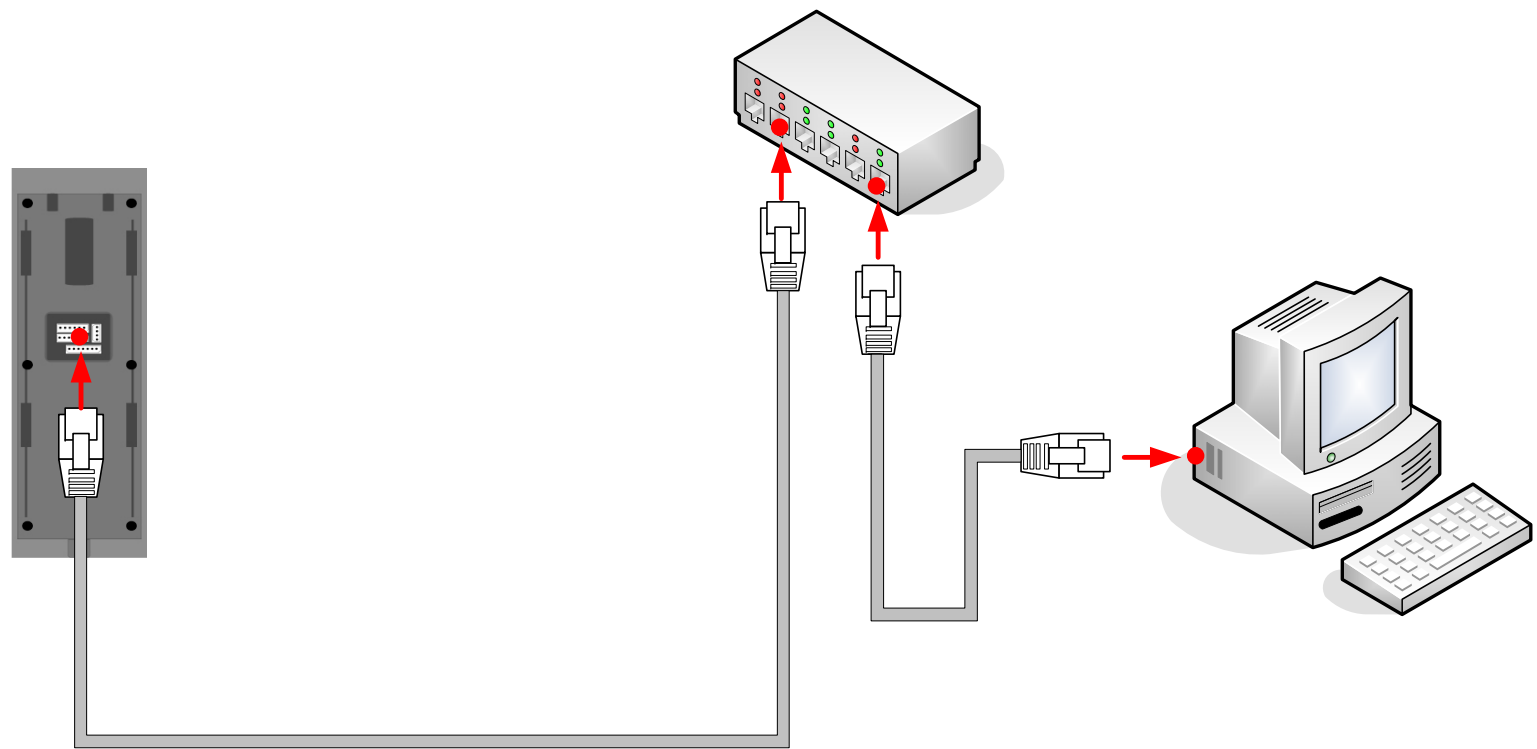

Ethernet Connection (Direct connection with PC)

- To connect BioEntry Plus with a PC directly, connect both devices with a straight CAT-5 cable. As the BioEntry Plus supports auto MDI/MDIX feature, it is not necessary to use a crossover type cable.

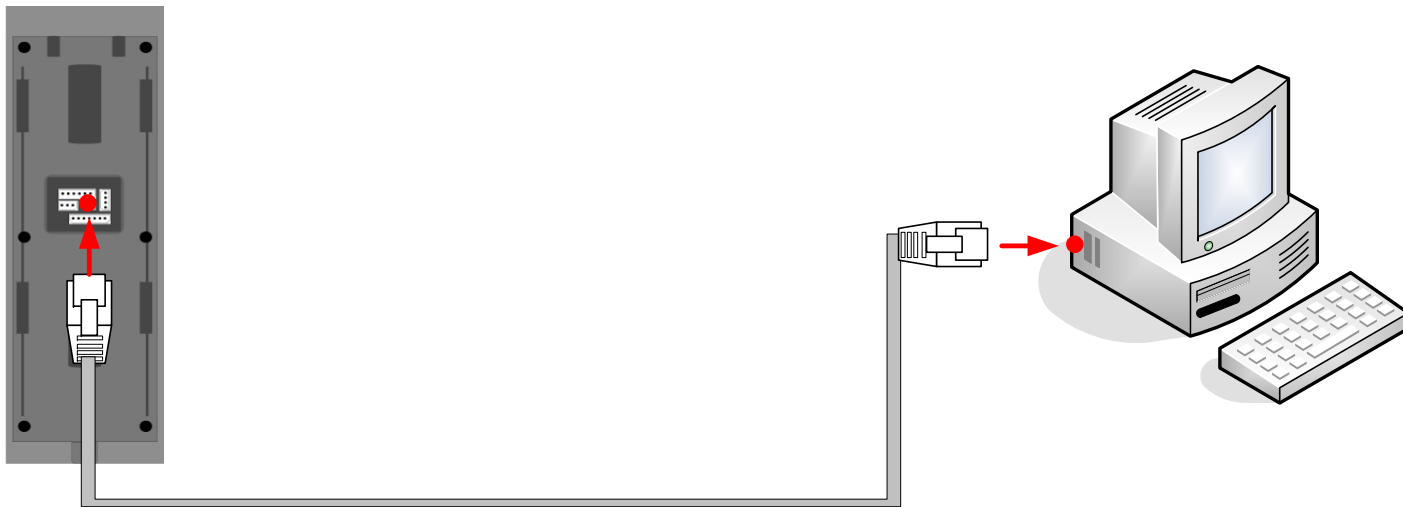

RS485 Connection for Host Communication

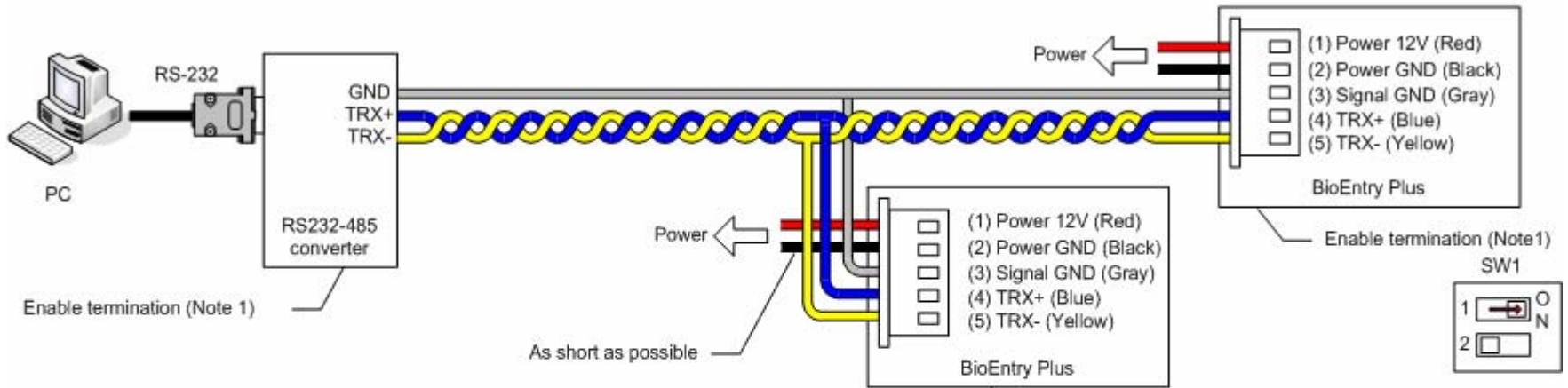

Important Notes

1. Only the devices at the both ends of the bus should be terminated. To enable termination on the RS232-485 converter, refer to the converter's manual.
2. Adjust the communication speed as needed. The signal quality vary depending on wiring conditions, and it may be necessary to lower the baudrates.
3. The GND signal may be omitted ***if and only if*** the GND potential difference is less than $\pm 5V$.

RS485 Connection for Secure I/O

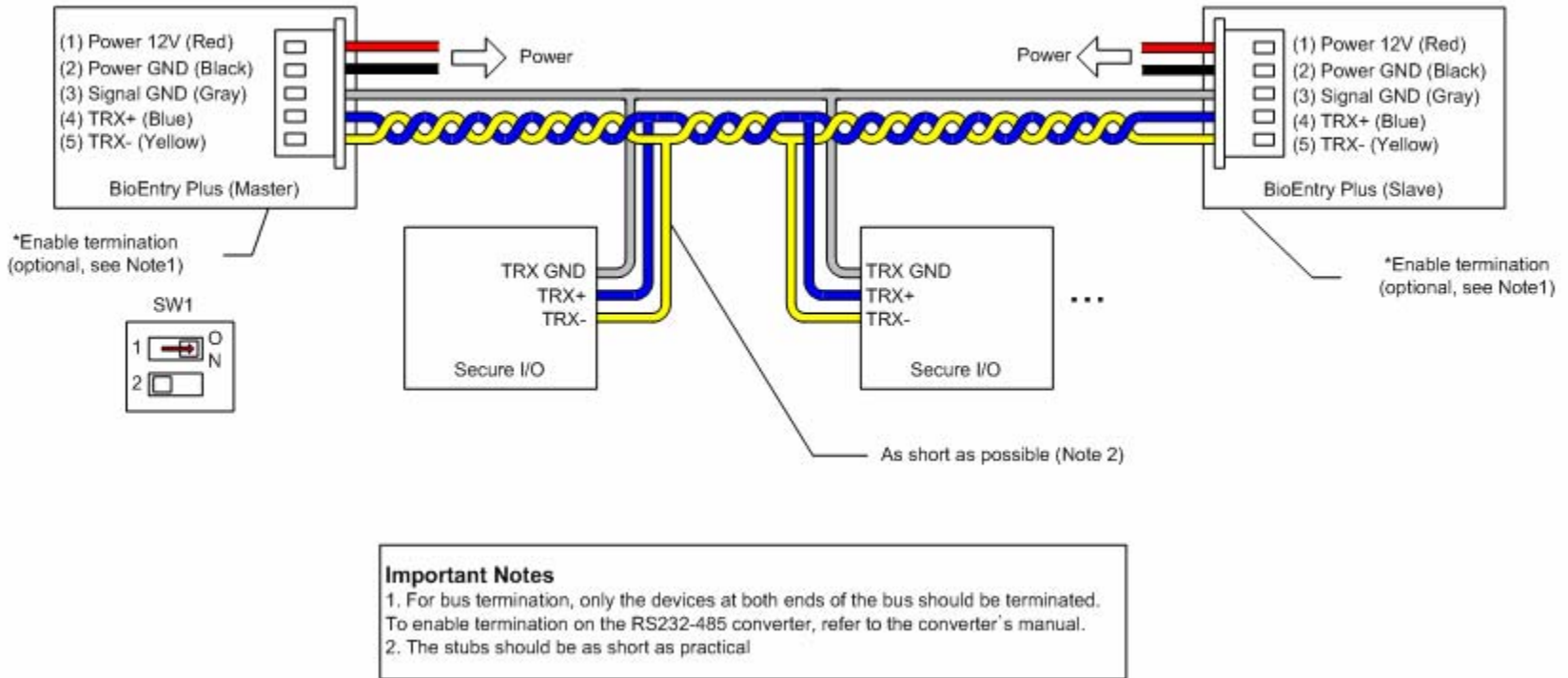

- **Max number of devices**

- **Maximum numbers of devices in an RS485 loop are two(2) devices (BioStation or BioEntry Plus) and four(4) Secure I/Os**

Relay Connection – Fail safe lock

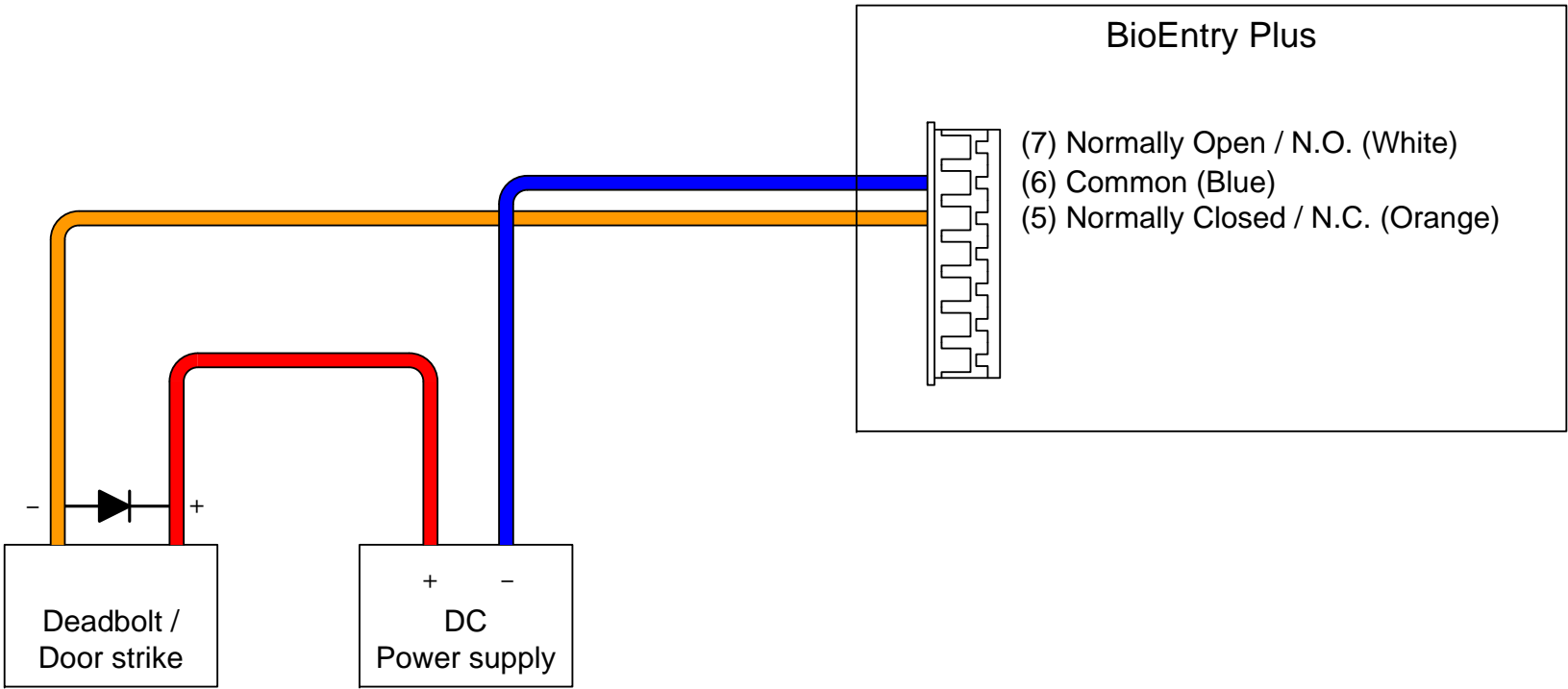

Relay Connection – Fail secure lock

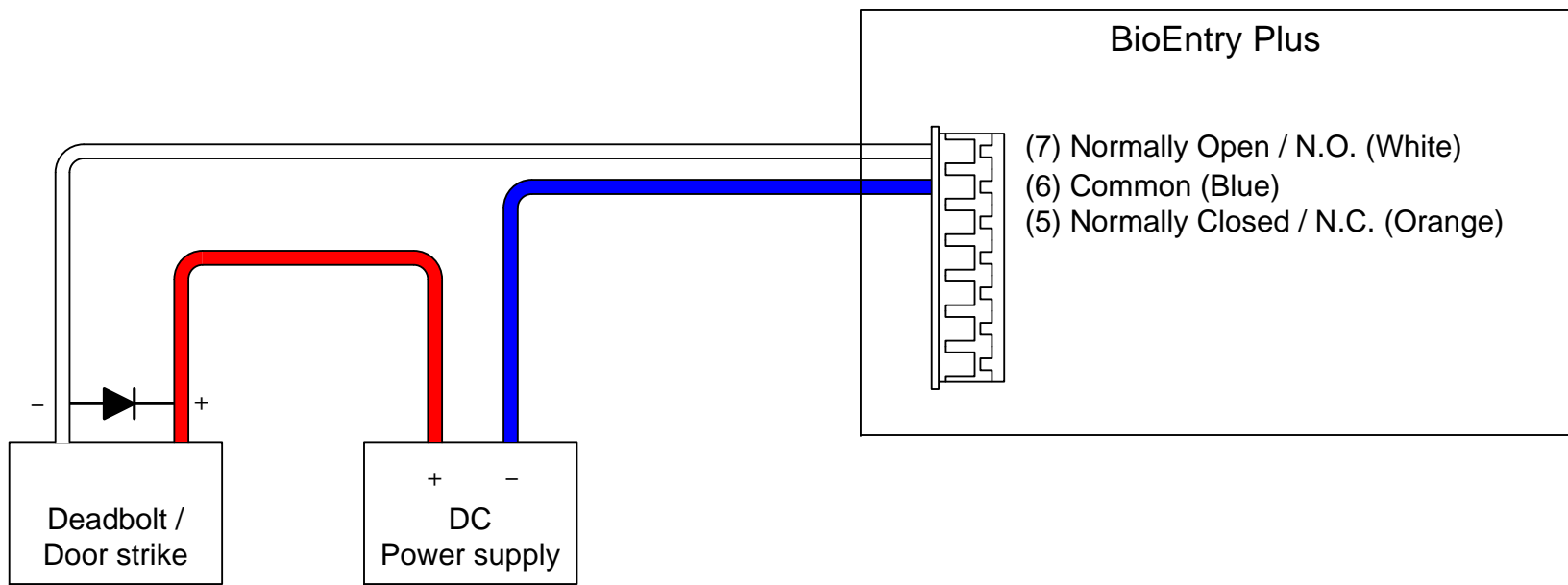

Relay Connection - Automatic door

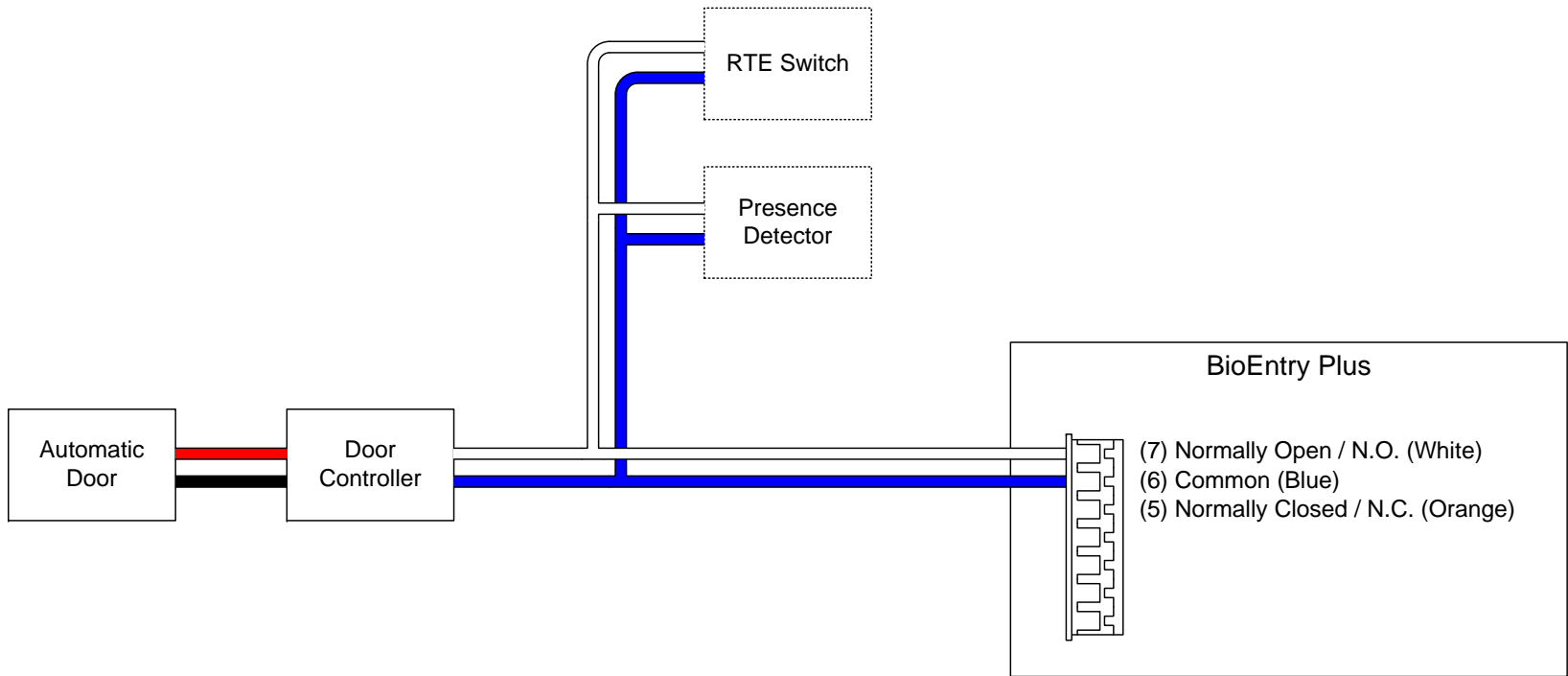

Digital Input Connection (RTE, Door sensor)

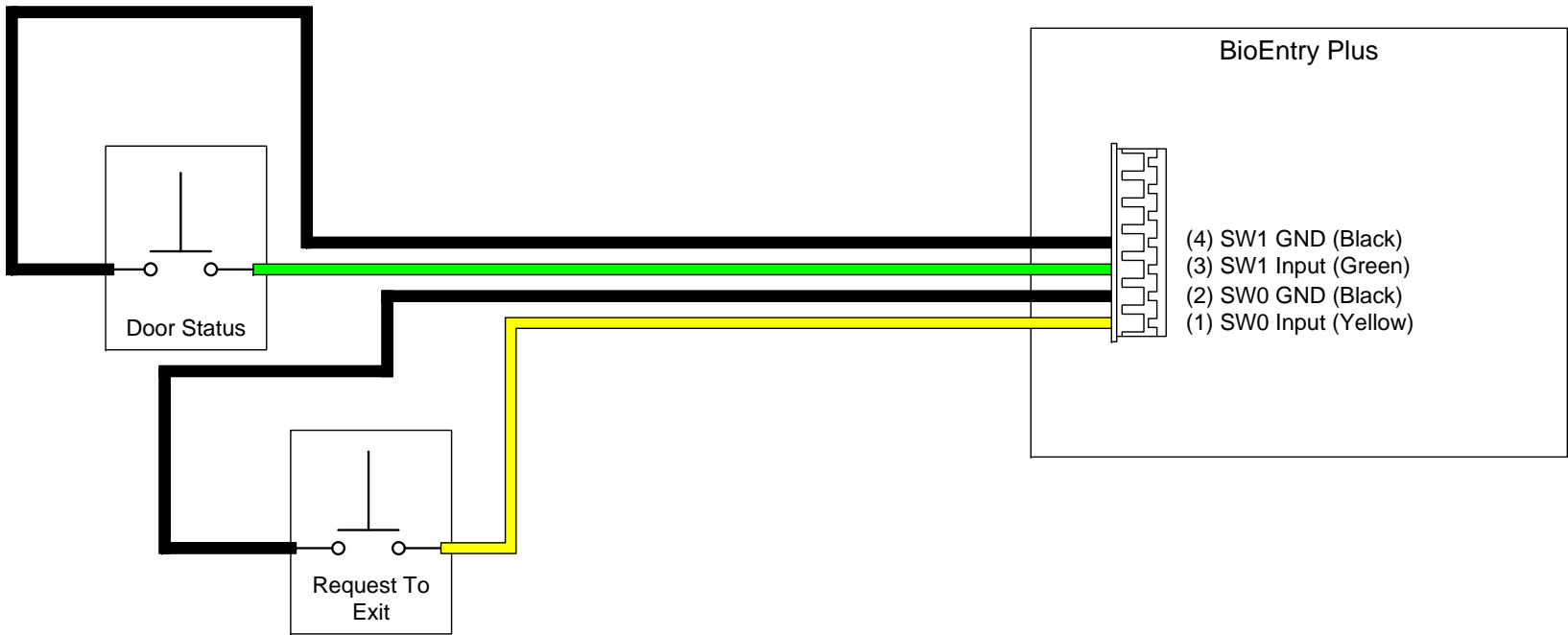

Digital Input Connection (Alarm, Emergency sw)

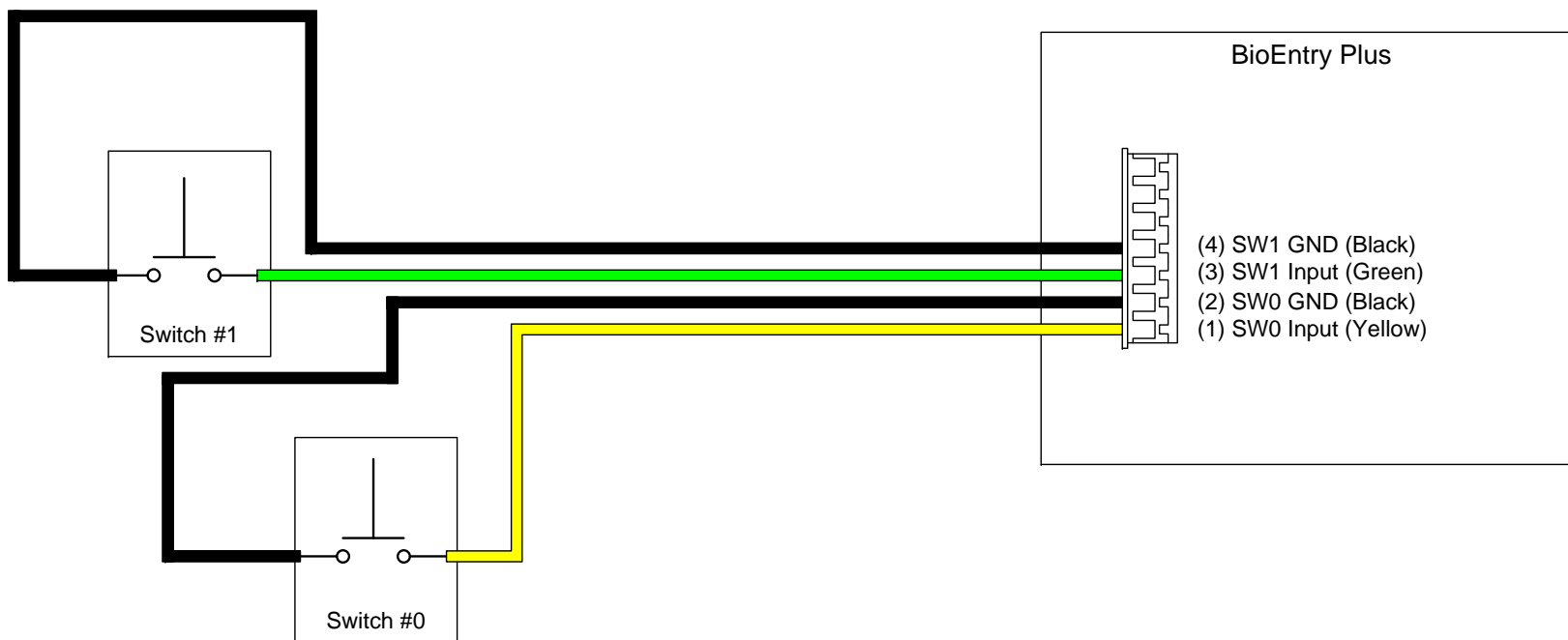

Wiegand Input/Output

■ Wiegand Input



■ Wiegand Output



Network Default Setting

- In case of forgetting network setting of BioEntry Plus (TCP/IP or RS-485 setting) during installation or using BioEntry Plus, user can initialize network setting (TCP/IP or RS-485 setting) by using DIP SW installed on the back panel of BioEntry Plus. Please refer to the figures in below.

How to initialize Network Setting

- 1. Turn off BioEntry Plus power.
- 2. Please make DIP SW #2 "ON" (Please refer to Fig.1)
- 3. After turning on BioEntry Plus power, user can modify TCP/IP or RS-485 setting what user wants.
 - Network Default Setting
 - TCP/IP Address : 192.168.0.1
 - Not checked "Use Server"
 - RS-485 : PC Connection, 115200bps
- 4. Please modify TCP/IP or RS-485 setting and save it.
- 4. Please make DIP SW #2 "OFF" (Please refer to Fig.2)
- 5. After recycling BioEntry Plus power, please check the modified TCP/IP or RS-485 setting.

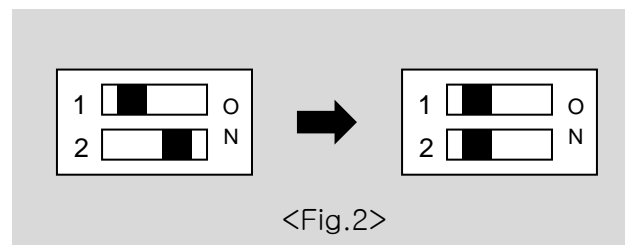
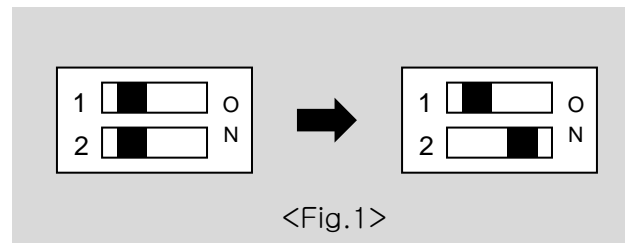

Installation Reference 1 - Stand alone

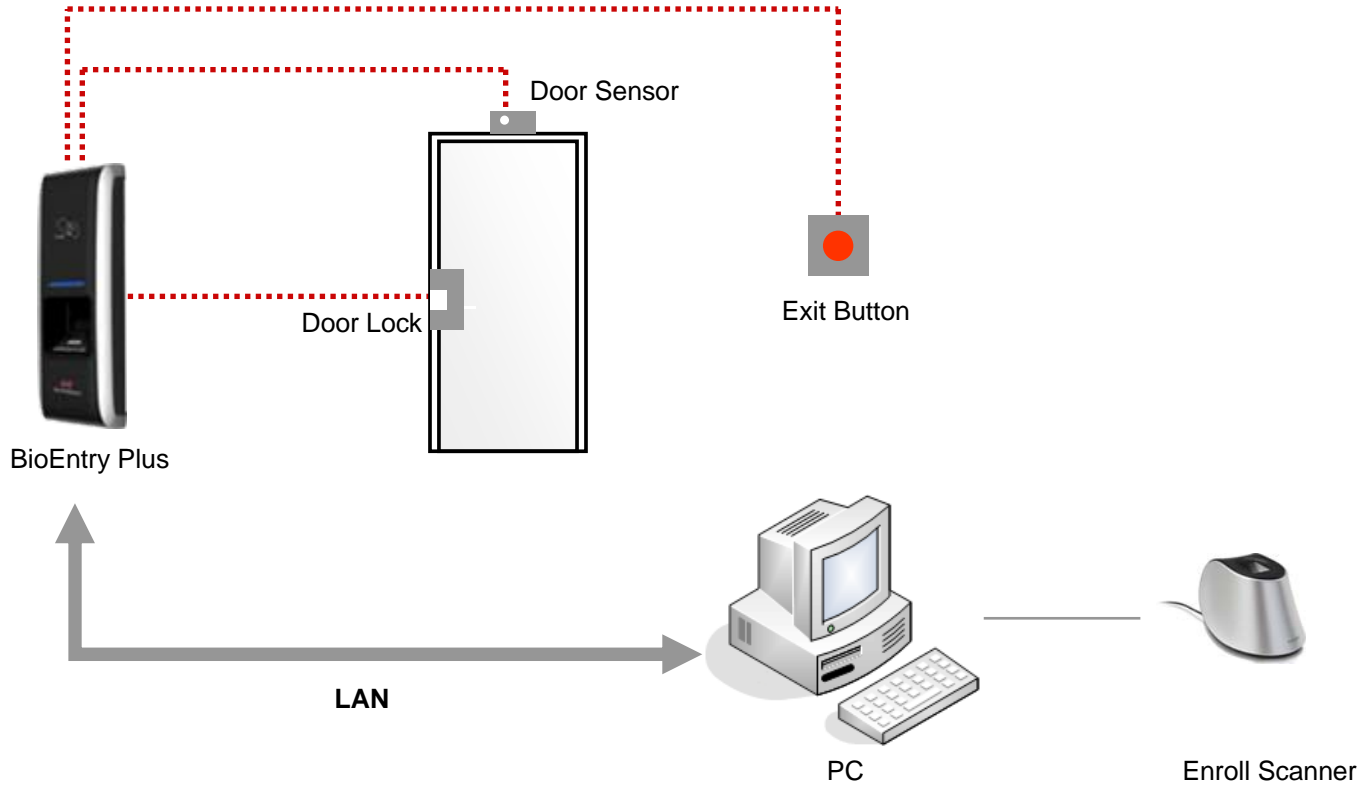

Installation Reference 2 – Secure

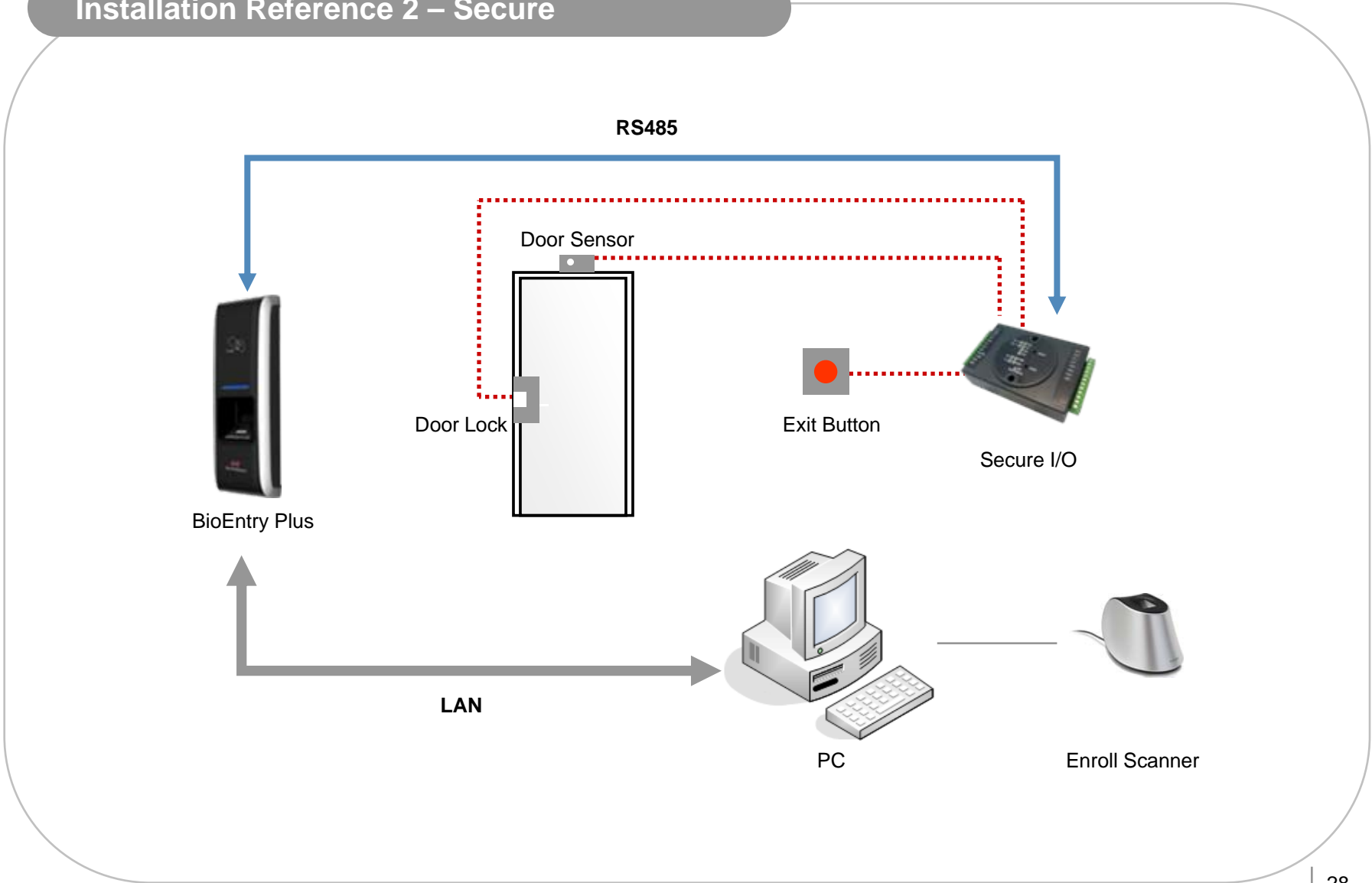

Installation Reference 3 – Network

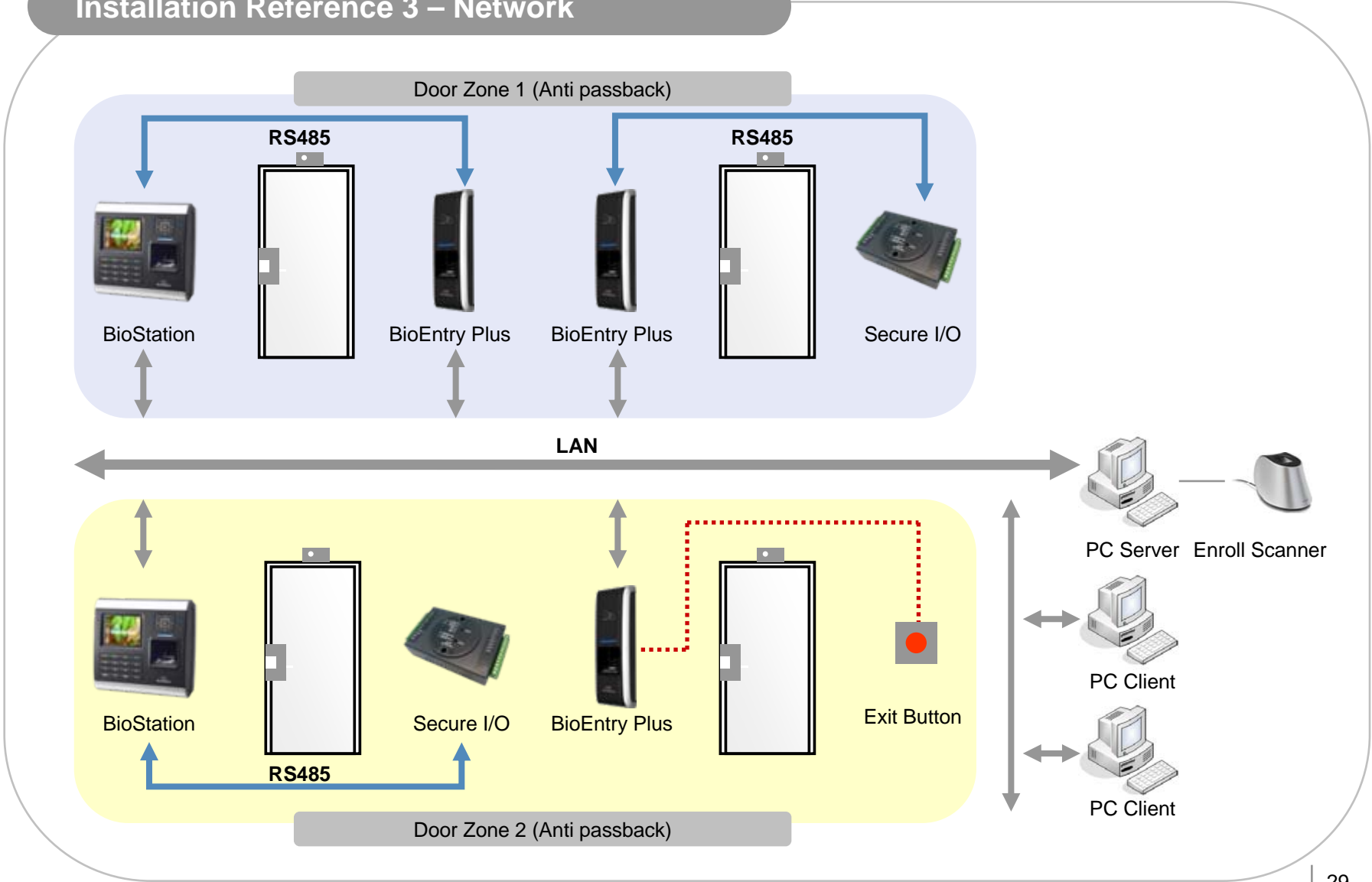

Electrical Specification

	Min.	Typ.	Max.	Notes
Power				
Voltage (V)	10.8	12	13.2	Use regulated DC power adaptor only
Current (mA)	-		250	
Switch Input				
V_{IH} (V)	-	TBD	-	
V_{IL} (V)	-	TBD		
Pull-up resistance (Ω)	-	4.7k	-	The input ports are pulled up with 4.7k resistors
TTL/Wiegand Output				
V_{OH} (V)	-	5	-	
V_{OL} (V)	-	0.8	-	
Pull-up resistance (Ω)	-	4.7k	-	The outputs ports are open drain type, pulled up with 4.7k resistors internally
Relay				
Switching capacity (A)	-	-	1 0.3	30V DC 125V AC
Switching power (resistive)	-	-	30W 37.5VA	DC AC
Switching voltage (V)	-	-	110 125	DC AC

Troubleshooting

- **Fingerprint can not be read well or it takes too long.**
 - Check whether a finger or fingerprint sensor is stained with sweat, water, or dust
 - Retry after wiping off finger and fingerprint sensor with dry towel.
 - If a fingerprint is way too dry, blow on the finger and retry.
- **Fingerprint is entered but authorization keeps failing.**
 - Check whether the user is restricted by door zone or time zone.
 - Inquire of administrator whether the enrolled fingerprint has been deleted from the device for some reason.
- **Authorized but door is not opened.**
 - Check whether the time is set as lock time.
 - Check whether an antipass back mode is in use. In antipass back mode, only who entered can exit.
- **Device doesn't operate though power is connected.**
 - Check whether a device and a bracket is well connected to each other. If not, a tamper switch is activated and the device doesn't work.

Device cleaning

- Wipe out machine surface with dry towel or cloth.
- In case there is dust or impurities on the sensor of the BioStation, wipe off the surface with dry towel.
- Note that if the sensor is cleaned by detergent, benzene or thinner, surface is damaged and fingerprint can't be entered.

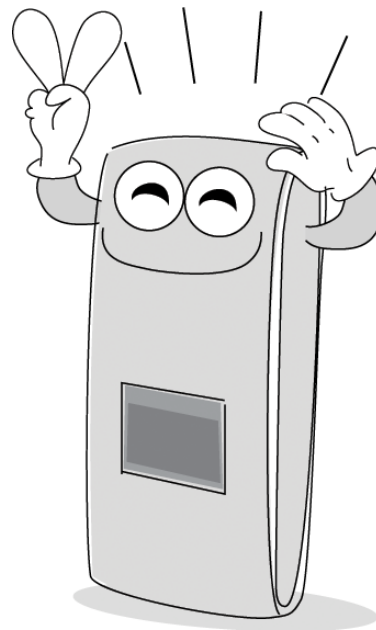
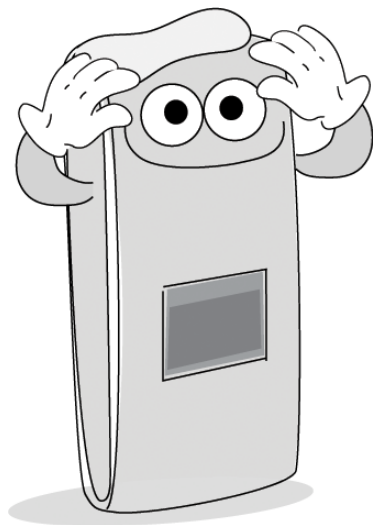

FCC Rules

Caution

- Changes or modifications not expressly approved by the manufacturer responsible for compliance could void the user's authority to operate the equipment.
- RISK OF EXPLOSION IF BATTERY IS REPLACED BY AN INCORRECT TYPE
- DISPOSE OF USED BATTERIES ACCORDING TO THE INSTRUCTIONS

Warning

- This device complies with part 15 of the FCC Rules. Operation is subject to the following two conditions: (1) This device may not cause harmful interference, and (2) this device must accept any interference received, including interference that may cause undesired operation.

Information to User

- This equipment has been tested and found to comply with the limit of a Class B digital device, pursuant to Part 15 of the FCC Rules. These limits are designed to provide reasonable protection against harmful interference in a residential installation. This equipment generates, user and can radiate radio frequency energy and, if not installed and used in accordance with the instructions, may cause harmful interference to radio communications. However, there is no guarantee that interference will not occur in a particular installation; if this equipment does cause harmful interference to radio or television reception, which can be determined by turning the equipment off and on, the user is encouraged to try to correct the interference by one or more of the following measures:
 1. Reorient / Relocate the receiving antenna.
 2. Increase the separation between the equipment and receiver.
 3. Connect the equipment into an outlet on a circuit different from that to which the receiver is connected.
 4. Consult the dealer or an experienced radio/TV technician for help

Specifications

Item	Specification
CPU	400MHz DSP
Fingerprint sensor	500dpi Optical / Capacitive sensor
User capacity	5000 users (10,000 templates)
Log capacity	50,000 events
Matching speed	Less than 1 second
Operation mode	Fingerprint, RF Card, RF card + Fingerprint
Network Interface	TCP/IP, RS485
Internal relay	Deadbolt, EM lock, door strike, automatic door
TTL I/O	2 inputs for exit switch and door sensor
Wiegand In/Out	1 Port (Wiegand Input or Wiegand Output is used according to the configuration.)
Sound and Interface	Multi-color LED and multi-tone buzzer
Rated Voltage	DC 12V (Min. 500mA and above) (When sharing the power with a device such as electric door lock, enough power is required considering the power requirement for the connected device.)
Card option	125kHz EM card (EM4100) 125kHz HID Proximity Card 13.56MHz Mifare Card
Size	50 x 160 x 37 mm (Width x Height x Depth)
Certified	KCC, CE, FCC



Suprema Inc.
16F Parkview Office Tower, Jeongja-dong, Bundang-gu,
Seongnam, Gyeonggi, 463-863 Korea
E-mail : support@supremainc.com
Website : www.supremainc.com

Functions and specifications of the product are subject to changes without notice due to quality enhancement or function update. For any inquiry on the product, please contact **Suprema Inc.**