



2N[®] Helios IP Uni

Door Access Intercom



Installation Manual

Version: 1.0.3

www.2n.cz

The 2N TELEKOMUNIKACE a.s. joint-stock company is a Czech manufacturer and supplier of telecommunications equipment.



The product family developed by 2N TELEKOMUNIKACE a.s. includes intercoms, GSM and UMTS products, private branch exchanges (PBXs) and M2M solution.

2N TELEKOMUNIKACE a.s. has been ranked among the Czech top companies for years and represents a symbol of prosperity in the field of IP intercoms. Furthermore, the company dedicates significant attention to operator solutions as well as to effectively providing support for our distribution network and customer service. At present, we export our products into over 120 countries worldwide and have exclusive distributors on all continents.



2N[®] is a registered trademark of 2N TELEKOMUNIKACE a.s.. Any product and/or other names mentioned herein are registered trademarks and/or trademarks or brands protected by law.



2N TELEKOMUNIKACE administers the FAQ database to help you quickly find information and to answer your questions about 2N products and services. On faq.2n.cz you can find information regarding products adjustment and instructions for optimum use and procedures „What to do if...“.



Declaration of Conformity

2N TELEKOMUNIKACE a.s. hereby declares that the 2N[®] Helios IP Uni product complies with all basic requirements and other relevant provisions of the 1999/5/EC directive. For the full wording of the Declaration of Conformity see www.2n.cz.



2N TELEKOMUNIKACE company is the owner of the ISO 9001:2008 certificate. All development, production and distribution processes of the company are managed by this standard and guarantee high quality, technical level and professional aspect of all our products.

Contents

1. Product Overview.....	5
1.1 Product Description	6
Basic Features.....	6
Advantages of Use	7
1.2 Upgrade	8
1.3 2N® Helios IP Uni Components and Associated Products.....	9
Basic Units.....	9
Mounting Accessories	10
VoIP Telephones.....	11
Electric Locks	11
Power Supply	11
Additional Modules	12
1.4 Terms and Symbols	13
Symbols.....	13
2. Description and Installation	15
2.1 Before You Start	16
Product Completeness Check.....	16
2.2 Mechanical Installation	17
Mounting Type Overview.....	17
Common Mounting Principles	18
Flush Mounting – Classic Bricks	19
Flush Mounting – Plasterboard	20
Wall Mounting.....	20
2.3 Electric Installation	21
PCB Connectors.....	21
2.4 Button Tags – Insertion and Replacement	23
Tag Printing	23
Tag Inserting / Replacing	23
3. Function and Use	25
3.1 2N® Helios IP Uni Configuration	26
3.2 2N® Helios IP Uni Control	27
Speed Dial Buttons.....	27
3.3 Maintenance.....	28
Cleaning	28
Future Tag Replacement, Programming Changes	28

4.	Technical Parameters	29
4.1	Technical Parameters	31
5.	Supplementary Information	33
5.1	Directives, Laws and Regulations	34
5.2	Troubleshooting	35
5.3	General Instructions and Cautions	36
	Electric Waste and Used Battery Pack Handling	37

1

Product Overview

In this section, we introduce the **2N® Helios IP Uni** product, outline its application options and highlight the advantages following from its use.

Here is what you can find in this section:

- Product Description
- Upgrade
- 2N® Helios IP Uni Components and Associated Products

1.1 Product Description

Basic Features

2N® Helios IP Uni is a highly resistant and reliable IP door access intercom provided with a lot of useful above-standard functions. Supporting the SIP standard and being compatible with the leading IP PBX and telephone suppliers, 2N® Helios IP Uni can make use of all VoIP services. 2N® Helios IP Uni can work as a standard or emergency door access intercom for buildings, entrances to premises or garages, manufacturing halls, highways and so on.

2N® Helios IP Uni is equipped with a loudspeaker (1W). Thanks to an integrated acoustic echo cancelling (AEC) system, the product provides mutual audibility even of persons talking at the same time under normal conditions.

2N® Helios IP Uni can be provided with 1 or 2 pre-programmed buttons. You can set up to three telephone numbers and time profiles for each of the buttons to increase the accessibility of the called party.

2N® Helios IP Uni is equipped with an electric lock switch. You can control the switch during a call, using any telephone set.

2N® Helios IP Uni is very easy to install. All you have to do is connect the system into your LAN via a network cable and feed it from a 12V power supply or your PoE supporting LAN.

Configure **2N® Helios IP Uni** using your PC via any web browser. Use the **2N® Helios IP Manager** to manage extensive 2N® Helios IP Uni systems easily and quickly.

Advantages of Use

- Variable mounting options (brick/plasterboard flush mounting, wall mounting)
- Sensitive microphone and powerful loudspeaker
- Bidirectional communication – acoustic echo cancelling
- Optional dial buttons including name tags and backlight
- Integrated electronic lock switches with wide setting options
- LAN (PoE) or external 12V power supply
- Configuration via web interface or dedicated PC application
- SIP 2.0 support
- HTTP server for configuration
- SNTP client for time synchronisation with server

1.2 Upgrade

The manufacturer reserves the right to modify the product in order to improve its qualities.

Version	Changes

1.3 2N® Helios IP Uni Components and Associated Products

Basic Units



9153101

1 button



9153102

2 buttons

2N® Helios IP Uni is designed for outdoor applications and requires no additional roof.

All 2N® Helios IP Uni units can be flush mounted without requiring any additional accessories. Use the appropriate mounting box (see below) for wall (surface) mounting.

Mounting Accessories



9153003
Wall mounting box
(Al casting)

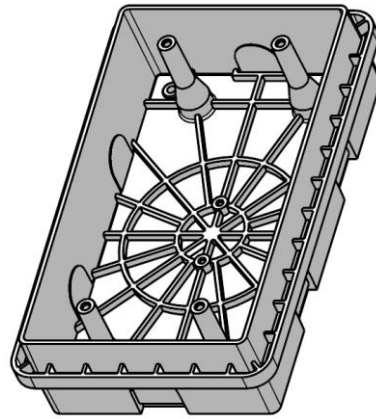

Brick flush mounting box
(included in the delivery)

VoIP Telephones



91378350

Grandstream GXV3140
VoIP video telephone



91378351

Grandstream GXV3175
VoIP telephone

Electric Locks



932070E

BEFO 1211 12V / 600 mA



932080E

BEFO 1221
with momentum pin



932090E

BEFO 1211MB
with mechanical blocking

Power Supply



91378100E
91378100US

PoE injector



91341481E

Adapter 12 V/2 A

A stabilised power supply
has to be used if the
Ethernet (PoE) power
supply is not available.



932928E

12 V transformer

Additional Modules



9159010

Security Relay



9137410E

External IP relay

1.4 Terms and Symbols

Symbols



Safety Warning

- **Always** abide by this information to prevent injury of persons!



Warning

- **Always** abide by this information to prevent damage to the device.



Caution

- **Important information** for system functionality.



Tip

- Useful advice.



Note

- Additional information.

2

Description and Installation

In this section we describe the **2N[®] Helios IP Uni** product and its installation.

Here is what you can find in this section:

- Before You Start
- Mechanical Installation
- Button Tags – Insertion and Replacement
- Electric Installation

2.1 Before You Start

Product Completeness Check

Please check the contents of your 2N[®] Helios IP Uni delivery:

- 1 2N[®] Helios IP Uni (selected model)
- 1 Torx 10 / Torx 20 double-ended wrench
- 1 2N[®] Helios IP Uni Installation Manual
- 1 mounting template
- 1 A5 transparent name plate foil
- 1 spare name plate
- 1 brick flush mounting box
- 4 4x12 stainless steel, torx screws for plastics
- 2 cable ties

2.2 Mechanical Installation

Mounting Type Overview

Refer to the table below for a list of mounting types and necessary components.

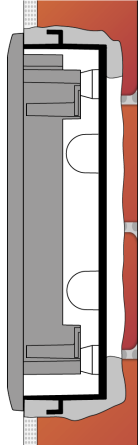
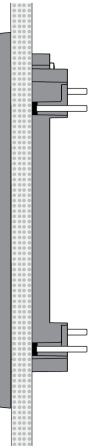
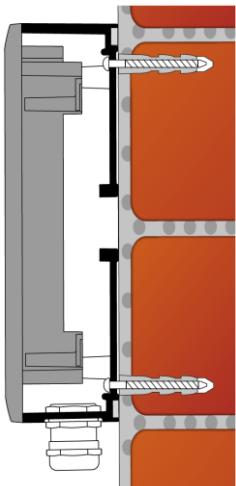
<p>Flush mounting – classic bricks (also hollow bricks, thermally insulated walls, etc.)</p> <p>What you need: A properly cut hole Plaster, mounting glue, mounting foam or mortar as necessary</p>	
<p>Flush mounting – plasterboard</p> <p>What you need: Just a properly cut hole</p>	
<p>Wall mounting (concrete and steel structures, entry barrier columns, etc.)</p> <p>What you need: Wall mounting box Part No. 9153003</p>	

**Caution**

- The warranty does not apply to the product defects and failures arisen as a result of improper mounting (in contradiction herewith). The manufacturer is neither liable for damage caused by theft within an area that is accessible after the attached electric lock is switched. The product is not designed as a burglar protection device except when used in combination with a standard lock, which has the security function.
- When the proper mounting instructions are not met, water might get in and destroy the electronics. It is because the intercom circuits are under continuous voltage and water infiltration causes an electro-chemical reaction. The manufacturer's warranty shall be void for products damaged in this way!

Common Mounting Principles

**Tip**

- Select flush mounting where possible to make your product elegant looking, more vandal resistant and more secure.

**Caution**

- Stainless steel screws are used for the 2N[®] Helios IP Uni assembly. Other screws than stainless steel ones corrode soon and may aesthetically deteriorate the surrounding environment!
- Having removed the front panel, make sure that no dirt gets inside the product (especially onto the sealing surface).

Flush Mounting – Classic Bricks

1. Cut a wall hole using the template enclosed. Make sure that all the required cables are available in the hole.
2. Unpack the plastic mounting box. Break out the cable holes as necessary and make sure that the wall hole is big enough for the box.
3. Wall up the mounting box making sure that the box is aligned with the wall surface. Wait until the plaster (mortar, mounting foam, etc.) sets.
4. Unscrew the front panel from the door intercom.
5. Connect the cables to the terminals or RJ connector as described in the **Electric Connection** subsection.
6. You can use the cable tie for connection as shown:

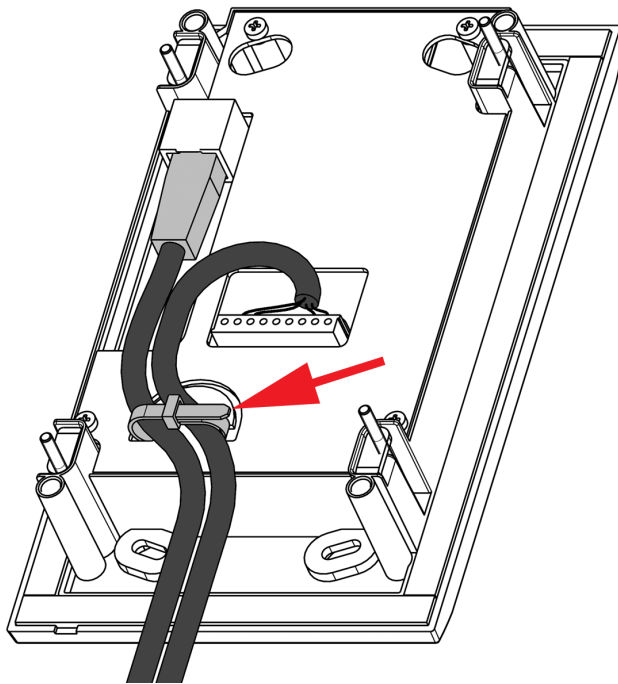

Suggested cable fixation

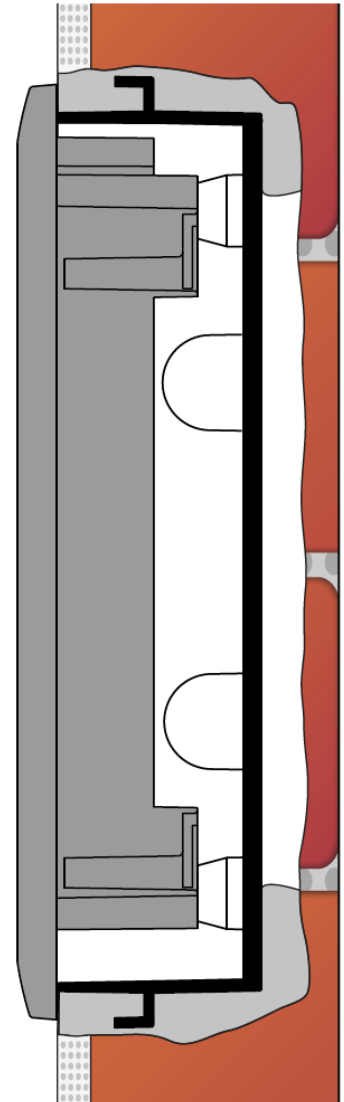

Mounting completion – after electric installation!

7. Insert the intercom in the mounting box in the wall.
8. Tighten the intercom with the stainless steel screws included in the delivery. As the screw holes are oval, you can perfect the vertical position before tightening.
9. We do not recommend you to insert the button tags now.
10. Replace the stainless steel front panel fixing it with the stainless steel screws you unscrewed in step 4 above.

Flush Mounting – Plasterboard



Tip

- If this is your first plasterboard installation, check the function of the intercom side clamps. Loosen and then re-tighten the clamp screw to see how it turns automatically and starts moving forwards in its slot. Remember to return the clamp into the original position after the check!

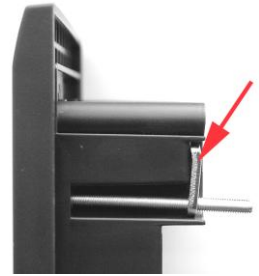

Caution

- Check the plasterboard wall and room interior pressure values (caused, e.g., by overpressure ventilation). If the difference between the values is too great, separate the intercom using, for example, the mounting box enclosed and seal the cable passage to avoid loudspeaker damage.

1. Cut a hole using the template enclosed (165 x 95 mm).
2. Unscrew the front panel from the door intercom.
3. Connect the cables in the hole to the terminals or RJ connector as described in the **Electric Connection** subsection.
4. You can use the cable tie for connection as shown on previous page.

Mounting completion – after electric installation!

5. Insert the intercom in the hole keeping it in the vertical position.
6. Loosen the four clamp screws one after another and then retighten them slowly. They will turn aside automatically and start moving forwards in their slots. You need about **10 turns** to tighten the clamps completely. You can perfect the vertical position before final tightening of the screws.
7. We do not recommend you to insert the button tags now.
8. Replace the stainless steel front panel fixing it with the stainless steel screws you unscrewed in step 2.

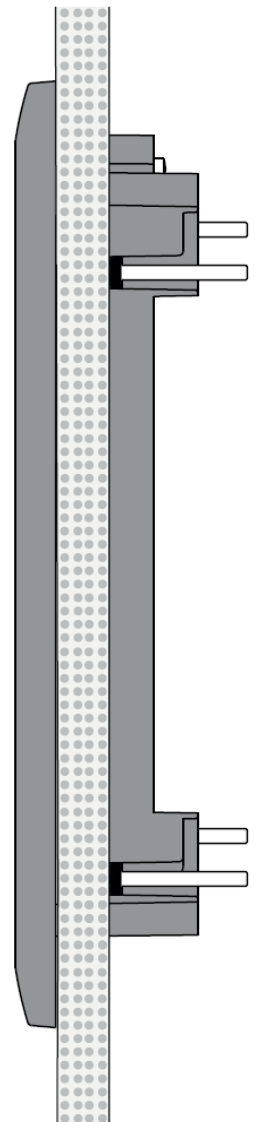

Wall Mounting

Use the wall (surface) mounting box, part No. **9153003**, and follow the instructions enclosed.

2.3 Electric Installation

This subsection describes how to connect 2N[®] Helios IP Uni into your Local Area Network (LAN) and how to connect supply voltage and the electric lock.

PCB Connectors

Description of Connectors

LAN	LAN connector
OUT1	12V/700 mA switched output
RELAY1	Relay NO/NC contacts
TAMPER	Tamper switch
POWER	12V/1A DC power input
RESET	RESET button

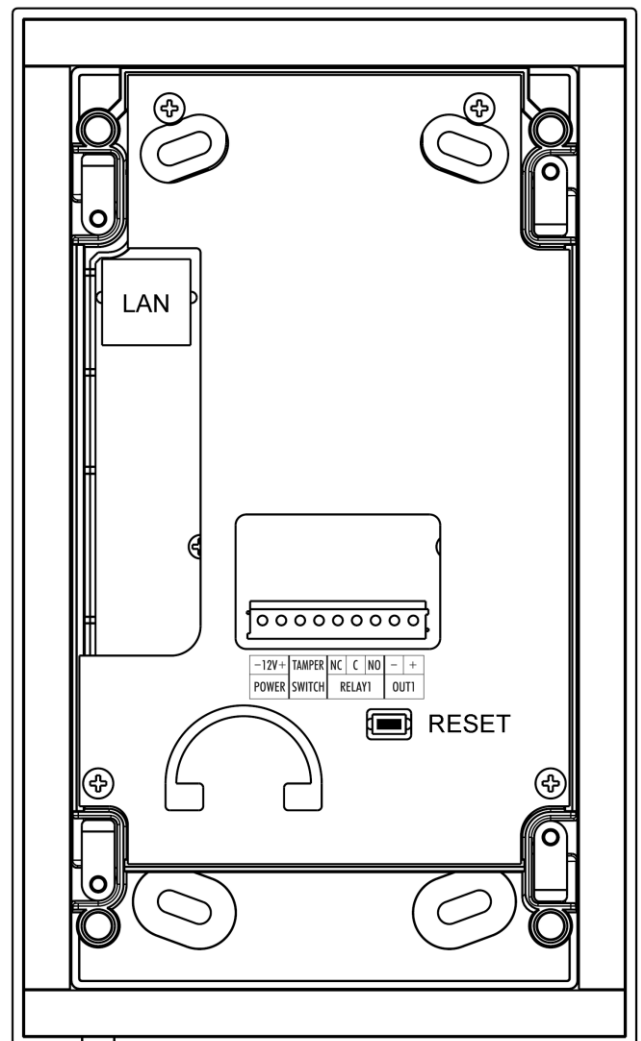

LAN Connection

2N[®] Helios IP Uni is connected to the LAN via a RJ-45 terminated (connector X11) UTP/STP cable (of category Cat 5e or higher). The system is equipped with the Auto-MDIX function and so both the straight and crossed cable versions can be used

External Power Supply Connection

2N[®] Helios IP Uni can be fed either from an external 12V/1A DC power supply or from the LAN equipped with the PoE 802.3af supporting network elements.

External Power Supply

An external 12V power supply is connected to terminal block X19. Use a 12V +- 15% DC power source dimensioned to current intake of 1A at least (Part No. 91341481E) to ensure a reliable function of your device.

PoE Supply

2N[®] Helios IP Uni is compatible with the PoE 802.3af (Class 0 – 12.95W) technology and can be supplied directly from the LAN via compatible network elements. If your LAN is incompatible, insert the PoE injector, Part No. 91758100E, between 2N[®] Helios IP Uni and the nearest network element.

Electric Lock Connection

2N[®] Helios IP Uni is equipped with an electrically isolated relay switch with NO and NC contacts (terminal block X17) and 12V/700mA switched output (terminal block X18), to which a standard electric lock or another compatible electrical appliance can be connected.

Tamper Switch Connection

2N[®] Helios IP Uni is equipped with a tamper switch for detection of unauthorized penetration into the device. After correct and complete installation of the device the tamper switch is closed. Tamper switch opens immediately when the front panel is removed. Tamper switch contacts are available on terminal block X18.

Device Resetting

2N[®] Helios IP Uni is equipped with a RESET button. Push the button for more than 10s to reset the factory default values, deleting all the data stored in the device. Push the button shortly (< 1s) to restart the device without changing its configuration.

2.4 Button Tags – Insertion and Replacement

Tag Printing

1. Every name plate includes a piece of foil, which can be written over manually, using a waterproof permanent marker.



Note

- Always use waterproof foil (enclosed or other) for the tags. Never use paper or ink jet printing to avoid damage due to water leakage!

Tag Inserting / Replacing

2N[®] Helios IP Uni provides an intuitive, easy access to the name plates. The tags are easy to insert and replace even without a manual. You need not remove the front panel and thus are not exposed to the risk of loss of components while replacing the tags.

1. Loosen the name plate screw using the wrench enclosed, for example. You can open the name plate window like a door without losing the tightened screw.
2. Remove the used or blank name tag and insert a new tag.
3. Close the name plate window and tighten the screw appropriately.
4. Check the click effect of the buttons: if the button fails to click properly when pressed (when moved by approx. 0.5 mm), the tag is too thick or thin. Make sure that the button clicks when you press it on either end.

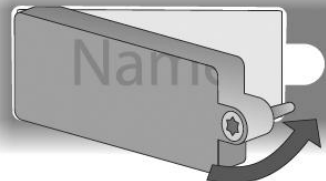
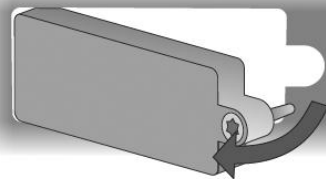
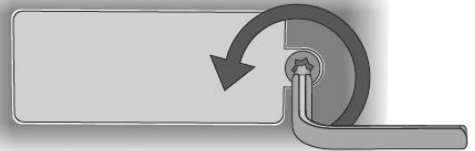

3

Function and Use

In this section we describe the basic and extending functions of the **2N® Helios IP Uni** product.

Here is what you can find in this section:

- 2N® Helios IP Uni Configuration
- 2N® Helios IP Uni
- Maintenance

3.1 2N® Helios IP Uni Configuration

2N® Helios IP Uni Use a PC equipped with any web browser to configure:



- Launch your web browser (Internet Explorer, Firefox, etc.).
- Enter the IP address of your intercom (<http://192.168.1.100/>, e.g.).
- Log in using the **Admin** user name and **2n** password.

You have to know the IP address of your device to log in to the integrated web server. By default, 2N® Helios IP Uni is switched into the dynamic IP address mode, i.e. it obtains the IP address automatically if a properly set DHCP server is available in your LAN. If no such DHCP server is available, you can operate 2N® Helios IP Uni in the static IP address mode. Refer to the **2N® Helios IP Configuration Manual** for configuration details.

If your device remains inaccessible (you have forgotten the IP address, or the LAN configuration has changed, for example), change the LAN settings using the buttons on the device.

Static/Dynamic Address Setting Mode Switching

In case your 2N® Helios IP Uni device is equipped with 1 or 2 buttons, you can switch the modes using one button only.

- Connect 2N® Helios IP Uni to the power supply (or, disconnect and reconnect it if already connected).
- Wait for the first acoustic signal .
- Press button 1 fifteen times.
- The acoustic signal  indicates mode switching.
- Wait until the device is restarted automatically.

Note: The 15-times-1 sequence must be entered within 30 seconds after the first sound signal for security reasons. The inter-digit delay may be 2s at most

The static IP address mode will be switched into the dynamic IP address mode and vice versa upon restart.

3.2 2N® Helios IP Uni Control

This subsection describes how to control 2N® Helios IP Uni when viewed by an external user.

Speed Dial Buttons

Press the speed dial buttons on the basic unit to make quick dialling for the first 1 or 2 (depending on the model type) in the telephone directory. Call setup is signalled by a long intermittent tone or otherwise as configured in the PBX connected.

Repeated pressing of one and the same speed dial button during call setup may initiate call termination, or call termination plus dialling the next telephone number of the called subscriber, or may be assigned no function.

3.3 Maintenance

Cleaning

If used frequently, 2N® Helios IP Uni gets dirty. To clean it, use a piece of soft cloth moistened with clean water. We recommend you to obey the following principles while cleaning:

- Never use aggressive detergents (such as abrasives or strong disinfectants).
- Alcohol-based cleaners may be applied.
- Clean the device in dry weather in order to make waste water evaporate quickly.

Future Tag Replacement, Programming Changes

For necessary steps refer to the preceding subsections. Keep the following for future changes:

- This manual
- Unused transparent foil strips for button tags

Always use the product for the purpose it was designed and manufactured for, in compliance herewith.

The manufacturer reserves the right to modify the product in order to improve its qualities.

2N® **Helios** contains no environmentally harmful components. When the product's service life is exhausted and you would like to dispose of it please do so in accordance with applicable legal regulations.

4

Technical Parameters

In this section we describe the technical parameters of the **2N® Helios IP Uni** product.

4.1 Technical Parameters

Signalling protocol	SIP (UDP)
Buttons	
Button design	Transparent, white backlit buttons with easily replaceable name tags
Button count	1 or 2
Audio	
Microphone	1 integrated microphone
Amplifier	1W (class D)
Loudspeaker	1W
Volume control	Adjustable with automatic adaptive mode
Full duplex	Yes (AEC)
Audio stream	
Protocols	RTP/RTSP
Codecs	G.711
Interfaces	
Power supply	12V+-15%/1A DC or PoE
PoE	PoE 802.3af (Class 0 - 12.95W)
LAN	10/100BASE-TX s Auto-MDIX, RJ-45
Recommended cabling	Cat-5e or higher
Passive switch	NO and NC contacts, up to 30V/1A AC/DC
Active switch output	12V/700mA DC
Mechanical properties	
Cover	ABS plastic, high-quality stainless steel
Working temperature	-40°C to 55°C
Working relative humidity	10% to 95% (non-condensing)
Storing temperature	-40°C to 70°C
Dimensions	193 x 115 x 39 mm 197 x 119 x 47 mm with flush mounting box 193 x 115 x 57 mm for wall mounting
Weight	Product net weight..... 500 g Mounting box 135 g Total weight incl. package ... 800 g
Covering level	IP54



Declaration of Conformity

2N TELEKOMUNIKACE a.s. hereby declares that this product complies with all basic requirements and other relevant provisions of the 1999/5/EC directive. For the full wording of the Declaration of Conformity see www.2n.cz.

Industry Canada

This Class B digital apparatus complies with Canadian ICES-003.

Cet appareil numérique de la classe B est conforme à la norme NMB-003 du Canada.



This device complies with part 15 of the FCC Rules. Operation is subject to the following two conditions: (1) This device may not cause harmful interference, and (2) this device must accept any interference received, including interference that may cause undesired operation.



Note

- This equipment has been tested and found to comply with the limits for a Class B digital device, pursuant to part 15 of the FCC Rules. These limits are designed to provide reasonable protection against harmful interference in a residential installation. This equipment generates, uses and can radiate radio frequency energy and, if not installed and used in accordance with the instructions, may cause harmful interference to radio communications. However, there is no guarantee that interference will not occur in a particular installation. If this equipment does cause harmful interference to radio or television reception, which can be determined by turning the equipment off and on, the user is encouraged to try to correct the interference by one or more of the following measures:
 - Reorient or relocate the receiving antenna
 - Increase the separation between the equipment and receiver
 - Connect the equipment into an outlet on a circuit different from that to which the receiver is connected
 - Consult the dealer or an experienced radio/TV technician for help.



Caution

- Changes or modifications to this unit not expressly approved by the party responsible for compliance could void the user's authority to operate this equipment.
- Always use the product for the purpose it was designed and manufactured for, in compliance herewith.
- The manufacturer reserves the right to modify the product in order to improve its qualities.
- This device contains no environmentally harmful components. When the product's service life is exhausted and you would like to dispose of it please do so in accordance with applicable legal regulations.

5

Supplementary Information

This section provides supplementary information on the **2N® Helios IP Uni** product.

Here is what you can find in this section:

- Applicable Directives, Laws and Regulations

5.1 Directives, Laws and Regulations

2N[®] Helios IP Uni conforms to the following directives and regulations:

- Directive 1999/5/EC of the European Parliament and of the Council, of 9 March 1999 – on radio equipment and telecommunications terminal equipment and the mutual recognition of their conformity
- Directive 2006/95/EC of the European Parliament and of the Council of 12 December 2006 on the harmonisation of the laws of Member States relating to electrical equipment designed for use within certain voltage limits
- Directive 2004/108/EC of the Council of 15 December 2004 on the harmonisation of the laws of Member States relating to electromagnetic compatibility
- Directive 2011/65/EU of the European Parliament and of the Council of 8 June 2011 on the restriction of the use of certain hazardous substances in electrical and electronic equipment
- Regulation (EC) No. 1907/2006 of the European Parliament and of the Council of 18 December 2006 concerning the Registration, Evaluation, Authorisation and Restriction of Chemicals (REACH), establishing a European Chemicals Agency, amending Directive 1999/45/EC and repealing Council Regulation (EEC) No. 793/93 and Commission Regulation (EC) No. 1488/94 as well as Council Directive 76/769/EEC and Commission Directives 91/155/EEC, 93/67/EEC, 93/105/EC and 2000/21/EC
- Directive 2002/96/EC of the European Parliament and of the Council of 27 January 2003 on waste electrical and electronic equipment.
- Commission Regulation (EC) No. 1275/2008, of 17 December 2008, implementing Directive 2005/32/EC of the European Parliament and of the Council with regard to ecodesign requirements for standby and off mode electric power consumption of electrical and electronic household and office equipment

5.2 Troubleshooting



For tips concerning solutions of other potential problems see faq.2n.cz.

5.3 General Instructions and Cautions

Please read this User Manual carefully before using the product. Follow all instructions and recommendations included herein.

Any use of the product that is in contradiction with the instructions provided herein may result in malfunction, damage or destruction of the product.

The manufacturer shall not be liable and responsible for any damage incurred as a result of a use of the product other than that included herein, namely undue application and disobedience of the recommendations and warnings in contradiction herewith.

Any use or connection of the product other than those included herein shall be considered undue and the manufacturer shall not be liable for any consequences arisen as a result of such misconduct.

Moreover, the manufacturer shall not be liable for any damage or destruction of the product incurred as a result of misplacement, incompetent installation and/or undue operation and use of the product in contradiction herewith.

The manufacturer assumes no responsibility for any malfunction, damage or destruction of the product caused by incompetent replacement of parts or due to the use of reproduction parts or components.

The manufacturer shall not be liable and responsible for any loss or damage incurred as a result of a natural disaster or any other unfavourable natural condition.

The manufacturer shall not be held liable for any damage of the product arising during the shipping thereof.

The manufacturer shall not make any warrant with regard to data loss or damage.

The manufacturer shall not be liable and responsible for any direct or indirect damage incurred as a result of a use of the product in contradiction herewith or a failure of the product due to a use in contradiction herewith.

All applicable legal regulations concerning the product's installation and use as well as provisions of technical standards on electric installations have to be obeyed. The manufacturer shall not be liable and responsible for damage or destruction of the product or damage incurred by the consumer in case the product is used and handled contrary to the said regulations and provisions.

The consumer shall, at its own expense, obtain software protection of the product. The manufacturer shall not be held liable and responsible for any damage incurred as a result of the use of deficient or substandard security software.

The consumer shall, without delay, change the access password for the product after installation. The manufacturer shall not be held liable or responsible for any damage incurred by the consumer in connection with the use of the original password.

The manufacturer also assumes no responsibility for additional costs incurred by the consumer as a result of making calls using a line with an increased tariff.

Electric Waste and Used Battery Pack Handling



Do not place used electric devices and battery packs into municipal waste containers. An undue disposal thereof might impair the environment!

Deliver your expired electric appliances and battery packs removed from them to dedicated dumpsites or containers or give them back to the dealer or manufacturer for environmental-friendly disposal. The dealer or manufacturer shall take the product back free of charge and without requiring another purchase. Make sure that the devices to be disposed of are complete.

Do not throw battery packs into fire. Battery packs may not be taken into parts or short-circuited either.



2N TELEKOMUNIKACE a.s.

Modřanská 621, 143 01 Prague 4, Czech Republic

Tel.: +420 261 301 500, Fax: +420 261 301 599

E-mail: sales@2n.cz

Web: www.2n.cz